

Article number: 206153M16KSNMVK

Description: E+G stainless steel spring plungers 615.3-M16-KSN-MVK

Measures

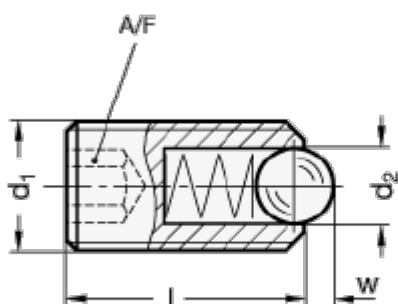

Thread locking **PFB**
Polyamide patch
for type **KN**



Thread locking **PFB**
Polyamide patch
for type **KSN**



Thread locking **MVK**
Micro encapsulation precote
(for all types)

A/F	= 8
d1	= M16
d2	= 10
l	= 33
Max. spring load in N	= 142
Preload spring pressure in N	= 68
w	= 3.5